

# Aesculap Surgical Technologies

## Titanium Ligating Clips and Appliers



# Clip Appliers for Open Surgery

## Clipanlegezangen für die offene Chirurgie

*New Generation / Neue Generation*



**Why be happy with anything less, when you can have all the advantages in one product?**

- Narrow, delicate instrument tips provide the optimum overview
- Special spring shape offers the greatest possible stability and secure clip holding
- Product variety - the perfect instrument for every indication
  - 150 mm, 203 mm and 280 mm instrument lengths
  - 25°, 65° and 90° jaw angles
- Colour coding for easy identification to the matching clip size

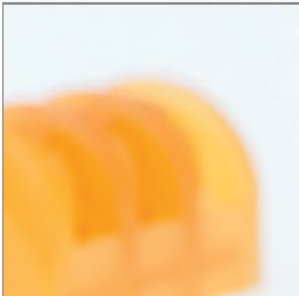

**Warum mit weniger zufrieden geben, wenn Sie alle Vorteile in einem Produkt haben können?**

- Schmale und feine Instrumentenspitzen bieten bestmögliche Übersicht
- Spezielle Federform bietet höchstmögliche Stabilität und sicheren Cliphalt
- Produktvielfalt – Für jede Indikation das perfekte Instrument
  - Instrumentenlängen 150 mm, 203 mm, 280 mm
  - Maulabwinkelungen 25°, 65° und 90°
- Farbcodierung zur leichten Identifikation der passenden Clipgröße



# Titanium Ligating Clips

## Titan Ligaturclips

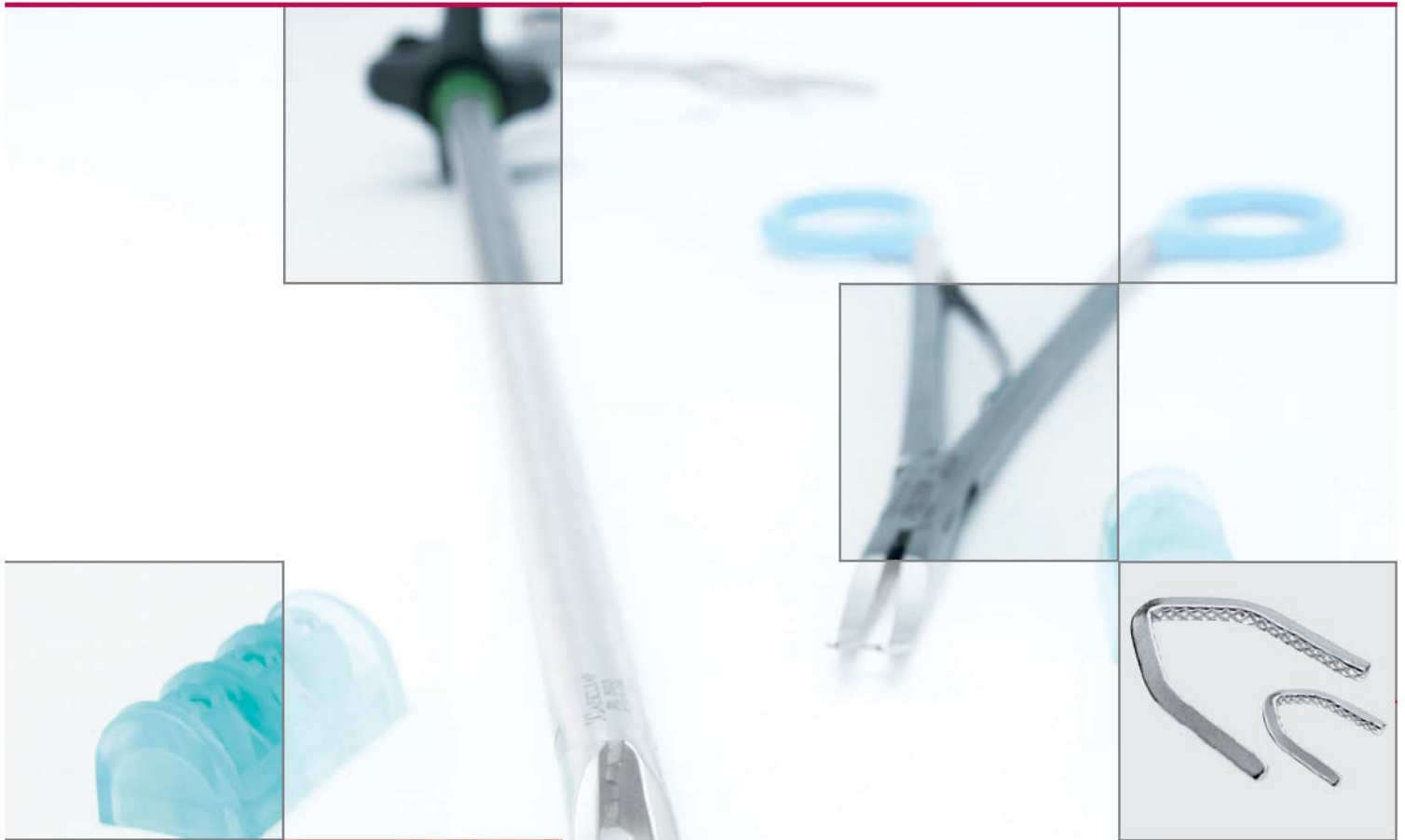

**FB270R**  
Clip tray for sticking on the clip cartridges  
Cliptray zum Aufkleben der Clipmagazine

**The new clip applicators combined with the tried and tested Aesculap titanium ligating clips, an ideal combination!**

- Special inner clip profiling provides the greatest possible contact surface and prevents the clip slipping out of place after application
- The special closing behaviour of the clip prevents undesirable tissue slippage
- Special soft load clip cartridge for extremely easy clip release
- Indentations on the cartridge sides for comfortable handling
- Adhesive surface on the cartridge for secure holding in every position

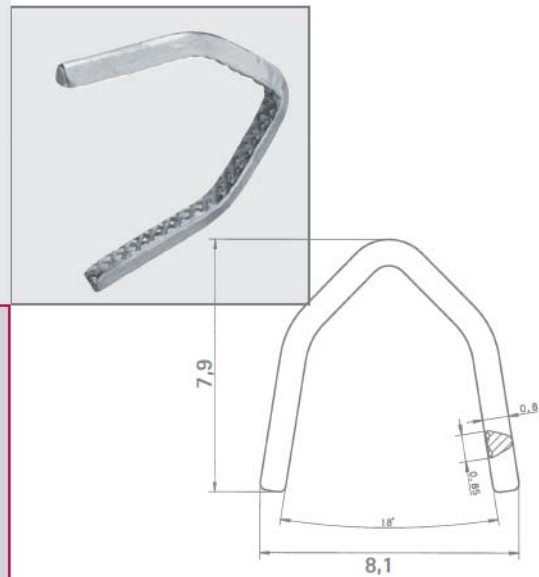

**Die neuen Clipanlegezangen in Verbindung mit den bewährten Aesculap Titan-Ligatur-Clips, eine ideale Kombination!**

- Spezielles Schließverhalten verhindert ungewolltes Herausrutschen von Gewebe aus dem Clip
- Rautenförmige Innenprofilierung des Clips bietet größtmögliche Kontaktfläche und verhindert ein Verrutschen des Clips nach der Applikation
- Spezielle Soft-Load-Clipmagazine für einfachste Clipentnahme
- Seitliche Griffmulden am Magazin für komfortables Halten
- Klebefläche am Magazin für sicheren Halt an jeder Stelle



**Challenger Ti**

Reusable multifire clip applicator for titanium clips C 461 11  
 Der resterilisierbare Clip-Applikator mit Multifire-Funktion zur Applikation von TITAN-Clips C 461 11

# Titanium Ligating Clips and Appliers

## Titan Ligaturclips und Anlegezangen

*small*



1/1

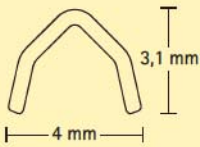

**PL565T**  
**PL566T Cardiopack**  
Titanium ligating clip  
small (yellow)  
Titan-Ligatur-Clip  
small (gelb)



Clip Applier small (yellow), 150 mm  
Clipanlegezange small (gelb), 150 mm

# *small*



Clip Applier small (yellow), 203 mm  
Clipanlegezange small (gelb), 203 mm



FB223R  
25°

FB226R  
65°



Clip Applier small (yellow), 280 mm  
Clipanlegezange small (gelb), 280 mm



FB224R  
25°

FB227R  
65°

# Titanium Ligating Clips and Appliers

## Titan Ligaturclips und Anlegezangen

*medium*

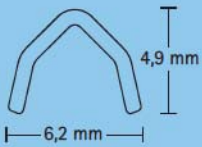

**PL567T**  
Titanium ligating clip  
medium (blue)  
Titan-Ligatur-Clip  
medium (blau)



**FB234R**  
25°

Clip Applier medium (blue), 150 mm  
Clipanlegezange medium (blau), 150 mm



**FB235R**  
25°

**FB238R**  
65°



Clip Applier medium (blue), 203 mm  
Clipanlegezange medium (blau), 203 mm



# medium



Clip Applier medium (blue), 280 mm  
Clipanlegezange medium (blau), 280 mm



**FB236R**  
25°



**FB239R**  
65°

- Rinsing channel for fast and safe cleaning of the shaft
- 360° revoluble shaft for exact and precise clip placement
- Colour coding for easy assignment to the matching clip size
- Spülkanal zur schnellen, sicheren Reinigung des Schaftes
- 360° drehbarer Schaft zur exakten und präzisen Clipplazierung
- Farbcodierung für leichte Zuordnung der passenden Clipgröße

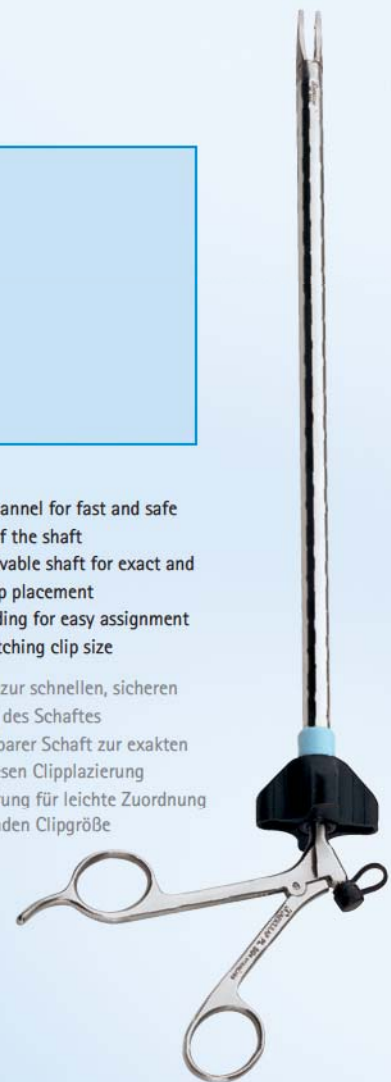

**PL504R**  
Endoscopic Clip Applier, medium,  
diam. 10 mm, length 330 mm  
Endoskopische Clipanlegezange, medium,  
Ø 10 mm, Länge 330 mm

# Titanium Ligating Clips and Appliers

## Titan Ligaturclips und Anlegezangen

*medium  
large*

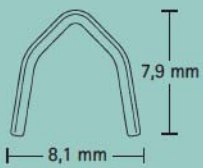

**PL568T**  
Titanium ligating clip  
medium-large (green)  
Titan-Ligatur-Clip  
medium-large (grün)



Clip Applier medium-large (green), 203 mm  
Clipanlegezange medium-large (grün), 203 mm

# medium-large



Clip Applier medium-large (green), 280 mm  
Clipanlegezange medium-large (grün), 280 mm



**FB242R**  
25°



**FB245R**  
65°



**FB255R**  
90°

- Rinsing channel for fast and safe cleaning of the shaft
- 360° revolvable shaft for exact and precise clip placement
- Colour coding for easy assignment to the matching clip size
- Spülkanal zur schnellen, sicheren Reinigung des Schaftes
- 360° drehbarer Schaft zur exakten und präzisen Clipplazierung
- Farbcodierung für leichte Zuordnung der passenden Clipgröße



**PL503R**  
Endoscopic Clip Applier, medium-large,  
diam. 10 mm, length 330 mm  
Endoskopische Clipanlegezange, medium-large,  
Ø 10 mm, Länge 330 mm

# Titanium Ligating Clips and Appliers

## Titan Ligaturclips und Anlegezangen

*large*

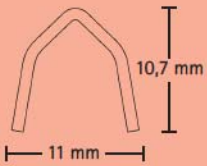
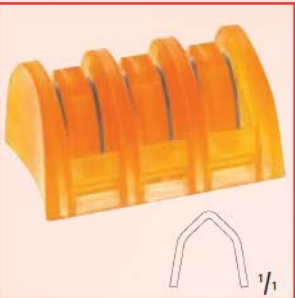

**PL561T**  
 Titanium ligating clip  
 large (orange)  
 Titan-Ligatur-Clip  
 large (orange)



Clip Applier large (orange), 203 mm  
 Clipanlegezange large (orange), 203 mm

# Large

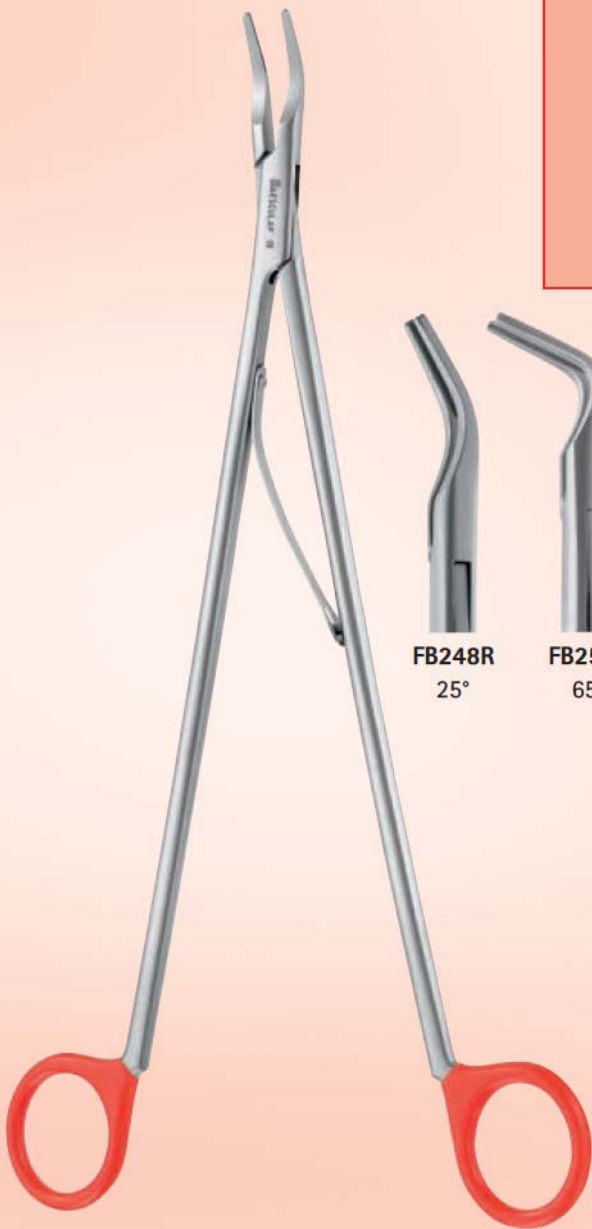

Clip Applier large (orange), 280 mm  
Clipanlegezange large (orange), 280 mm mm



FB248R  
25°

FB251R  
65°

FB253R  
90°

- Rinsing channel for fast and safe cleaning of the shaft
- 360° revolvable shaft for exact and precise clip placement
- Colour coding for easy assignment to the matching clip size
- Spülkanal zur schnellen, sicheren Reinigung des Schaftes
- 360° drehbarer Schaft zur exakten und präzisen Clipplazierung
- Farbcodierung für leichte Zuordnung der passenden Clipgröße



**PL528R**  
Endoscopic Clip Applier, large,  
diam. 12 mm, length 330 mm  
Endoskopische Clipanlegezange, large,  
Ø 12 mm, Länge 330 mm

# Order information

## Bestellinformation

	<i>small</i>	<i>medium</i>	<i>medium-large</i>	<i>large</i>
<b>Titanium Ligating Clips</b> Titan Ligatureclips	<b>PL565T</b> Available in packs of 30 cartridges à 6 Clips = 180 Clips Mengeneinheit: PA = 30 Magazine à 6 Clips = 180 Clips  <b>PL566T Cardiopack</b> Available in packs of 8 cartridges à 24 Clips = 192 Clips Mengeneinheit: PA = 8 Magazine à 24 Clips = 192 Clips	<b>PL567T</b> Available in packs of 30 cartridges à 6 Clips = 180 Clips Mengeneinheit: PA = 30 Magazine à 6 Clips = 180 Clips	<b>PL568T</b> Available in packs of 20 cartridges à 6 Clips = 120 Clips Mengeneinheit: PA = 20 Magazine à 6 Clips = 120 Clips	<b>PL561T</b> Available in packs of 20 cartridges à 6 Clips = 120 Clips Mengeneinheit: PA = 20 Magazine à 6 Clips = 120 Clips
<b>Appliers for Open Surgery</b> Anlegezangen für die offene Chirurgie	<b>FB222R</b> 150 mm, 25°  <b>FB223R</b> 203 mm, 25°  <b>FB226R</b> 203 mm, 65°  <b>FB224R</b> 280 mm, 25°  <b>FB227R</b> 280 mm, 65°	<b>FB234R</b> 150 mm, 25°  <b>FB235R</b> 203 mm, 25°  <b>FB238R</b> 203 mm, 65°  <b>FB236R</b> 280 mm, 25°  <b>FB239R</b> 280 mm, 65°	<b>FB240R</b> 203 mm, 25°  <b>FB243R</b> 203 mm, 65°  <b>FB254R</b> 203 mm, 90°  <b>FB242R</b> 280 mm, 25°  <b>FB245R</b> 280 mm, 65°  <b>FB255R</b> 280 mm, 90°	<b>FB246R</b> 203 mm, 25°  <b>FB249R</b> 203 mm, 65°  <b>FB252R</b> 203 mm, 90°  <b>FB248R</b> 280 mm, 25°  <b>FB251R</b> 280 mm, 65°  <b>FB253R</b> 280 mm, 90°
<b>Appliers for Minimal Invasive Surgery</b> Anlegezangen für die minimalinvasive Chirurgie		<b>PL504R</b> 330 mm Ø/diam. 10 mm	<b>PL503R</b> 330 mm Ø/diam. 10 mm	<b>PL528R</b> 330 mm Ø/diam. 12 mm

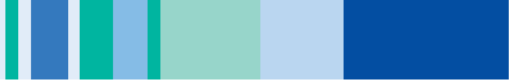

...just a click away!





AESCULAP®

**B | BRAUN**  
SHARING EXPERTISE

**Aesculap AG & Co. KG**

Am Aesculap-Platz  
78532 Tuttlingen  
Germany

Phone +49 7461 95-0  
Fax +49 7461 95-2600  
[www.aesculap.de](http://www.aesculap.de)

All rights reserved. Technical alterations are possible. This leaflet may be used for no other purposes than offering, buying and selling of our products. No part may be copied or reproduced in any form. In the case of misuse we retain the rights to recall our catalogues and pricelists and to take legal actions.